

Danfoss scroll compressors for refrigeration

High efficiency and reliability even in low temperatures **Cooler than ever!**

MLZ and LLZ scroll series for MBP and LBP refrigeration are efficient by design. Cut down operating costs and meet the most demanding food standards. LLZ & MLZ: the new names in scroll technology!

-40°C to +10°C

**Extended
compressor
range.**

Suits rack systems
and all applications
for refrigeration.



Danfoss **scroll compressors** for refrigeration applications

The MLZ and LLZ series are purpose-engineered for applications in refrigeration with respectively medium and low temperatures. They suit all operating conditions in different cooling systems.



Energy Savings

Optimize your system with the scroll compressors for refrigeration. The combination of an energy efficient motor and an optimized scroll wrap for refrigeration applications delivers high efficiency in fixed-speed compressors. Optional vapor injection boosts the cooling capacity and efficiency by more than 20%.



Low sound

Improve the sound environment with the lowest sound level in the industry. Scroll technology is quiet by design: the scroll provides smooth continuous compression, the absence of suction and discharge valves, and the unique disc check valve design ensure quiet, vibration-free operations.



Reliability

Improve your system reliability to reduce your maintenance and warranty costs. Reliability is built into this compressor range, from the compliant scroll design and the engineered bearings to the simplified manufacturing process (30% fewer parts). The patented thermal fault protection also contributes to excellent reliability. A smart way to reduce your field service costs.



Compactness

Footprint up to 30% smaller than alternative reduces the logistics costs and frees up space in the system.

Significant

annual cost savings with vapor injection.

Featured for immediate **benefits**

- Multi-refrigerant scrolls save on inventory
- Vapor injection available with optional activated economizer line kit increases LLZ efficiency and cooling capacity
- Optional sound jacket attenuates sound levels
- Suitable for transport of refrigerated goods



Wide operating envelopes **comply** with **all applications** in the refrigeration

**LLZ - R404A / R507 for low temperatures
With vapor injection**

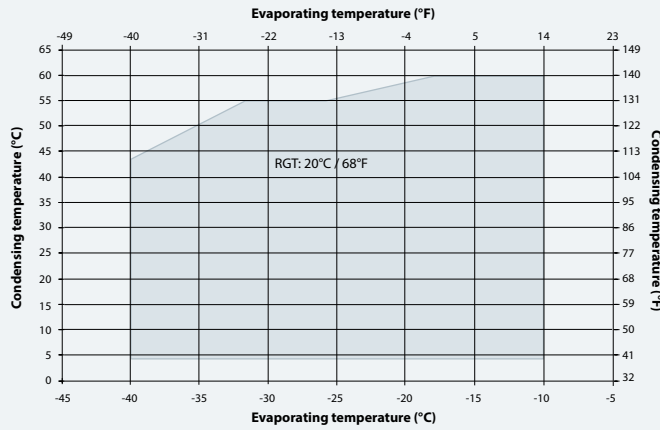

Boost cooling **capacity**
and efficiency with
vapor injection in low
temperatures

Danfoss proposes the optional activated economizer line kit to boost compressor efficiency and capacity with vapor injection. The system uses a liquid subcooler circuit. During the liquid subcooler process, some liquid refrigerant evaporates in the economizer and is injected into the scroll set at intermediate pressure. This provides additional cooling capacity thanks to subcooling in the economizer and increases efficiency of the system.

The effect of vapor injection increases together with the increase of the system pressure ratio.

MLZ - R404A / R507 for medium temperatures

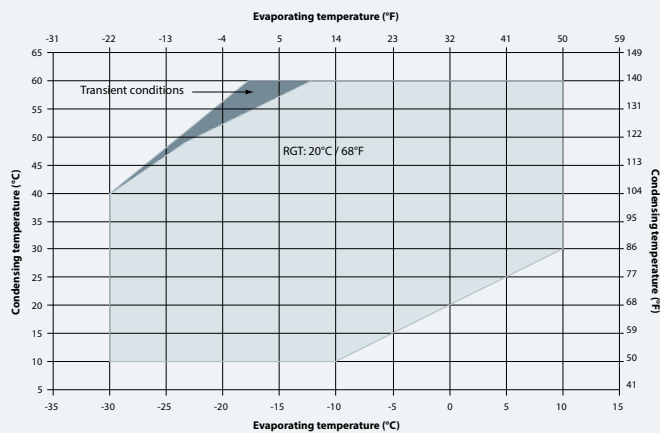

Dimensions

Dimensions in mm	H	H1	H2	D	Weight (kg)
LLZ 013-018	478	302	375	184	42
LLZ 024	533	342	415	184	46
LLZ 034	558	367	440	184	51
MLZ 015-026	393	231	360	165	31
MLZ 030-048	436	261	403	184	37
MLZ 058-076	528	350	499	232	45

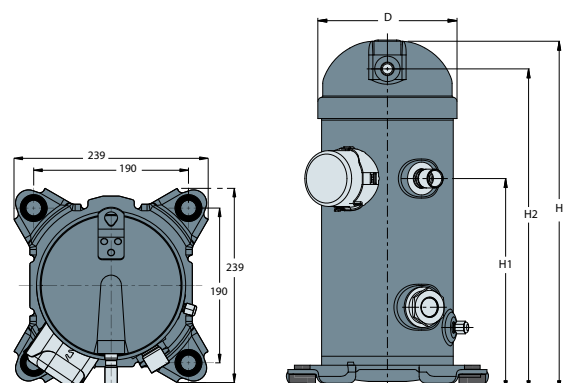

MLZ – medium temperatures

R134A

50Hz

	COOLING CAPACITY IN W / 40°C CONDENSING TEMPERATURE							EN12900				
	MLZ Models	-15°C	-10°C	-5°C	0°C	5°C	10°C	15°C	Cooling capacity W	Power input kW	COP W/W	Sound power dB(A)
50HZ • 380-400 V / 3-PHASES	MLZ015	1 650	2 100	2 640	3 280	4 030	4 900	5 890	1 980	1.02	1.94	67
	MLZ019	2 140	2 710	3 410	4 230	5 200	6 320	7 600	2 550	1.28	1.98	67
	MLZ021	2 280	2 880	3 620	4 490	5 520	6 710	8 070	2 700	1.33	2.04	67
	MLZ026	2 780	3 550	4 470	5 560	6 820	8 290	9 970	3 330	1.62	2.05	67
	MLZ030	3 370	4 280	5 380	6 690	8 220	9 990	12 020	4 020	1.93	2.09	69
	MLZ038	3 930	5 030	6 340	7 880	9 670	11 740	14 110	4 720	2.34	2.02	70
	MLZ045	4 900	6 240	7 880	9 820	12 060	14 590	17 430	5 840	2.69	2.17	71
	MLZ048	5 200	6 630	8 350	10 390	12 730	15 400	18 410	6 200	2.91	2.13	71
	MLZ058	6 190	7 920	9 940	12 290	15 000	18 110	21 650	7 400	3.61	2.05	74
	MLZ066	7 240	9 210	11 540	14 270	17 430	21 050	25 150	8 610	4.10	2.1	74
	MLZ076	8 040	10 250	12 870	15 940	19 470	23 520	28 100	9 600	4.67	2.05	74

EN 12900 MBP: Evaporating temperature: -10°C; Condensing temperature: 45°C; Subcooling 0K; Superheat 10K

60Hz

	COOLING CAPACITY IN W / 40°C CONDENSING TEMPERATURE							ARI				
	MLZ Models	-15°C	-10°C	-5°C	0°C	5°C	10°C	15°C	Cooling capacity W	Power input kW	COP W/W	Sound power dB(A)
60HZ • 460 V / 3-PHASES	MLZ015	2 010	2 590	3 300	4 110	5 040	6 090	7 260	2 720	1.30	2.1	71
	MLZ019	2 570	3 340	4 240	5 290	6 490	7 840	9 350	3 510	1.68	2.08	71
	MLZ021	2 690	3 550	4 520	5 630	6 890	8 320	9 940	3 740	1.74	2.15	71
	MLZ026	3 390	4 390	5 570	6 950	8 530	10 300	12 260	4 600	2.10	2.19	71
	MLZ030	4 080	5 290	6 720	8 370	10 260	12 390	14 770	5 550	2.57	2.16	73
	MLZ038	4 860	6 210	7 870	9 830	12 080	14 600	17 390	6 520	3.05	2.14	74
	MLZ045	5 960	7 650	9 670	12 030	14 750	17 820	21 260	7 870	3.64	2.16	74
	MLZ048	6 350	8 130	10 250	12 720	15 560	18 770	22 380	8 370	3.88	2.16	75
	MLZ058	7 630	9 710	12 160	15 010	18 260	21 950	26 080	10 040	4.69	2.14	78
	MLZ066	8 790	11 160	13 970	17 230	20 980	25 220	29 980	11 530	5.34	2.16	78
	MLZ076	9 940	12 540	15 670	19 330	23 540	28 290	33 580	12 960	6.16	2.1	78

ARI MBP: Evaporating temperature: -6.7°C ; Condensing temperature: 48.9°C; Subcooling 0K; Superheat 11.1K

Operating envelope

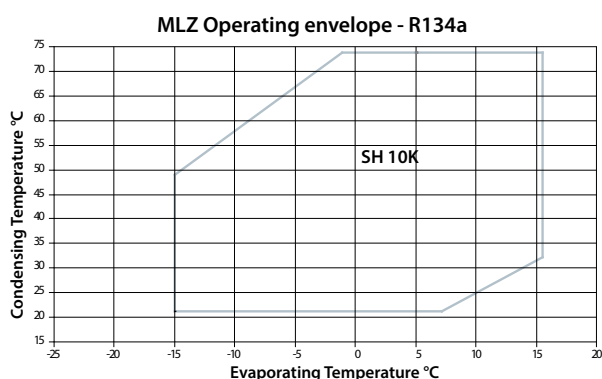

MLZ compressors may be blue or black depending on the manufacturing origin



MLZ – medium temperatures

50 Hz

	MLZ Models	COOLING CAPACITY IN W / 40°C CONDENSING TEMPERATURE								EN12900			
		-25°C	-20°C	-15°C	-10°C	-5°C	0°C	5°C	10°C	Cooling capacity W	Power input kW	COP W/W	Sound power dB(A)
50HZ • 380-400 V / 3-PHASES	MLZ015	1 660	2 180	2 770	3 450	4 240	5 150	6 210	7 420	3 080	1.75	1.76	65
	MLZ019	2 360	2 990	3 730	4 580	5 570	6 730	8 090	9 670	4 150	2.16	1.93	65
	MLZ021*	2 510	3 180	3 950	4 850	5 910	7 150	8 600	10 260	4 410	2.27	1.94	65
	MLZ026*	3 060	3 860	4 810	5 940	7 280	8 860	10 690	12 810	5 410	2.90	1.86	67
	MLZ030*	3 700	4 700	5 870	7 260	8 890	10 790	12 980	15 490	6 600	3.35	1.97	70
	MLZ038*	4 500	5 680	7 060	8 690	10 600	12 810	15 370	18 280	7 880	3.86	2.05	71
	MLZ045*	5 350	6 810	8 540	10 570	12 950	15 710	18 890	22 530	9 560	4.89	1.95	71
	MLZ048*	5 810	7 460	9 380	11 610	14 190	17 160	20 560	24 420	10 490	5.38	1.95	72
	MLZ058*	6 450	8 450	10 750	13 410	16 460	19 960	23 940	28 430	12 110	6.08	1.99	74
	MLZ066*	7 640	9 850	12 450	15 530	19 130	23 320	28 150	33 680	14 060	7.01	2.01	74
	MLZ076	9 550	11 980	14 780	18 060	21 930	26 510	31 920	38 250	16 160	7.93	2.04	74

EN 12900 MBP: Evaporating temperature: -10°C; Condensing temperature: 45°C; Subcooling 0K; Superheat 10K

* Models certified by Asercom

60 Hz

	MLZ Models	COOLING CAPACITY IN W / 40°C CONDENSING TEMPERATURE								ARI			
		-25°C	-20°C	-15°C	-10°C	-5°C	0°C	5°C	10°C	Cooling capacity W	Power input kW	COP W/W	Sound power dB(A)
60HZ • 460 V / 3-PHASES	MLZ015	2 060	2 680	3 400	4 220	5 180	6 290	7 560	9 030	4 020	2.29	1.76	68
	MLZ019	2 920	3 690	4 580	5 630	6 850	8 250	9 870	11 710	5 400	2.81	1.92	68
	MLZ021	3 100	3 920	4 890	6 010	7 310	8 800	10 510	12 440	5 780	2.98	1.94	68
	MLZ026	3 890	4 880	6 070	7 460	9 080	10 950	13 090	15 490	7 160	3.75	1.91	70
	MLZ030	4 560	5 730	7 130	8 770	10 680	12 880	15 390	18 210	8 410	4.25	1.98	73
	MLZ038	5 420	6 880	8 570	10 520	12 790	15 400	18 400	21 820	10 120	5.13	1.97	74
	MLZ045	6 640	8 350	10 370	12 750	15 510	18 710	22 360	26 500	12 240	6.16	1.99	74
	MLZ048	7 260	9 110	11 320	13 940	16 980	20 480	24 450	28 910	13 380	6.71	1.99	75
	MLZ058	8 080	10 410	13 210	16 500	20 320	24 690	29 630	35 140	15 380	8.01	1.92	77
	MLZ066	9 810	12 340	15 350	18 900	23 040	27 810	33 270	39 440	18 160	9.14	1.99	77
	MLZ076	11 370	14 250	17 630	21 620	26 290	31 760	38 110	45 420	20 500	10.43	1.97	77

ARI MBP: Evaporating temperature: -6.7°C; Condensing temperature: 48.9°C; Subcooling 0K; Superheat 11.1K

Operating envelope

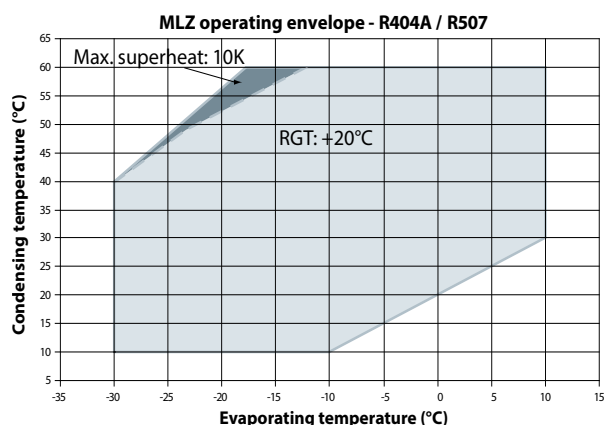

LLZ – low temperatures

R404A

50 Hz

	LLZ Models	COOLING CAPACITY IN W / 40°C CONDENSING TEMPERATURE						EN12900					
		-40°C	-35°C	-30°C	-25°C	-20°C	-15°C	-10°C	Cooling capacity W	Power input kW	COP W/W	Sound power dB(A)	
50HZ • 380-400V / 3-PHASES	LLZ013	1 850	2 420	3 100	3 900	4 850	5 960	7 260	2 420	2.37	1.02	78	
	LLZ015	2 270	2 940	3 750	4 750	5 940	7 350	9 020	2 940	2.78	1.06	80	
	LLZ018	2 670	3 450	4 410	5 580	6 980	8 650	10 610	3 450	3.15	1.1	83	
	LLZ024	3 400	4 410	5 640	7 130	8 920	11 040	13 560	4 410	3.96	1.11	85	
	LLZ034*	4 700	6 050	7 680	9 650	12 010	14 820	18 160	6 050	5.46	1.11	85	
	With economizer												
	LLZ013-Eco.	3 240	4 040	4 950	5 960	7 060	8 250	9 510	4 040	3.01	1.34	78	
	LLZ015-Eco.	3 930	4 840	5 880	7 060	8 410	9 930	11 650	4 840	3.51	1.38	80	
	LLZ018-Eco.	4 680	5 770	7 000	8 410	10 020	11 830	13 880	5 770	4.04	1.43	83	
	LLZ024-Eco.	5 880	7 240	8 800	10 570	12 580	14 860	17 440	7 240	4.99	1.45	85	
LLZ034-Eco.*	8 190	9 910	11 910	14 220	16 860	19 860	23 230	9 910	6.60	1.50	85		

LLZ models without economizer: EN 12900 LBP. evap. Temp. -35°C; cond. Temp. 40°C; Subcooling 0K; Superheat 10K
 LLZ models with economizer: evap. Temp. -35°C; cond. Temp. 40°C; Subcooling 5K; Superheat 10K - * preliminary data

60 Hz

	LLZ Models	COOLING CAPACITY IN W / 40°C CONDENSING TEMPERATURE						ARI					
		-40°C	-35°C	-30°C	-25°C	-20°C	-15°C	-10°C	Cooling capacity W	Power input kW	COP W/W	Sound power dB(A)	
60HZ • 460V / 3-PHASES	LLZ013	-	-	4 200	5 180	6 320	7 620	9 090	3 860	2.94	1.32	80	
	LLZ015	-	-	5 130	6 370	7 830	9 540	11 520	4 730	3.51	1.35	83	
	LLZ018	-	-	6 110	7 580	9 320	11 360	13 720	5 630	4.03	1.40	84	
	LLZ024	-	-	7 630	9 470	11 640	14 180	17 130	7 020	4.89	1.44	86	
	LLZ034*	-	-	10 630	13 120	16 020	19 380	23 260	9 810	6.62	1.48	86	
	With economizer												
	LLZ013-Eco.	3 990	5 060	6 170	7 350	8 640	10 070	11 670	5 780	3.57	1.62	80	
	LLZ015-Eco.	4 910	6 000	7 300	8 820	10 520	12 390	14 430	6 830	4.26	1.60	83	
	LLZ018-Eco.	5 870	7 160	8 730	10 540	12 570	14 810	17 240	8 160	4.86	1.68	84	
	LLZ024-Eco.	7 270	8 880	10 810	13 050	15 570	18 350	21 360	10 110	5.93	1.70	86	
LLZ034-Eco*.	10 140	12 540	14 900	17 450	20 440	24 100	28 690	14 050	8.05	1.74	86		

LLZ models without activated economizer line: ARI LBP: evap. Temp.: -31.7°C ; cond. Temp.: 40.6°C ; Subcooling 0K; Return gas temperature 18.3°C
 LLZ models with activated economizer line: ARI LBP: evap. Temp.: -31.7°C ; cond. Temp.: 40.6°C ; Subcooling 5K; Return gas temperature 18.3°C - * preliminary

Operating envelopes

LLZ operating envelope without activated economizer line (R404A/R507)

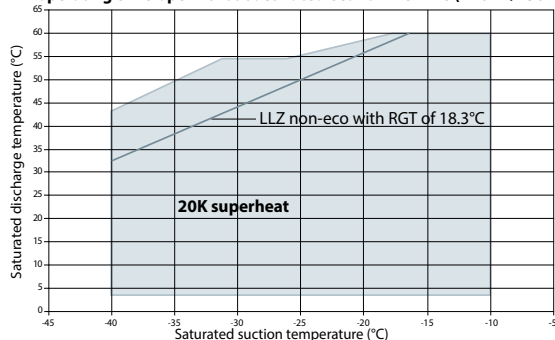

LLZ operating envelope with activated economizer line (R404A/R507)

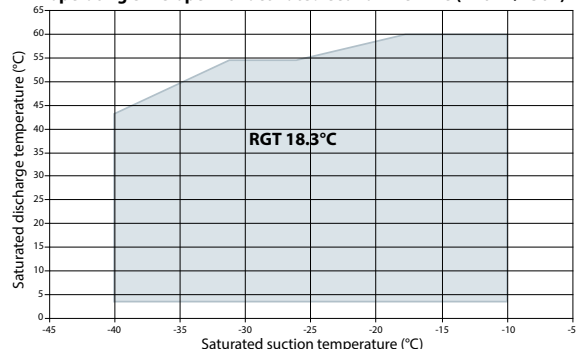

Danfoss can accept no responsibility for possible errors in catalogues, brochures and other printed material. Danfoss reserves the right to alter its products without notice. This also applies to products already on order provided that such alterations can be made without consequential changes being necessary in specifications already agreed. All trademarks in this material are property of the respective companies. Danfoss and the Danfoss logotype are trademarks of Danfoss A/S. All rights reserved.